



PARTNER
IN DESIGN
Innovative
Design Solutions

doxa

TRIM

doxa

**PARTNER
IN DESIGN**
Innovative
Design Solutions

TRIM

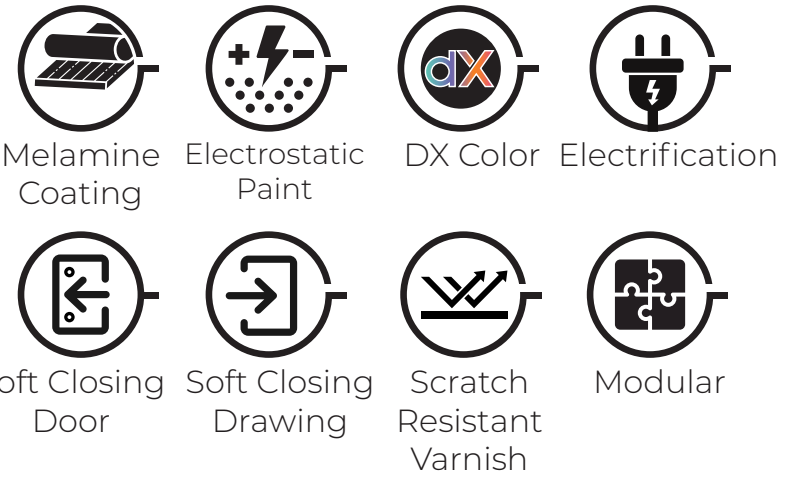

OPERATIONAL SERIES

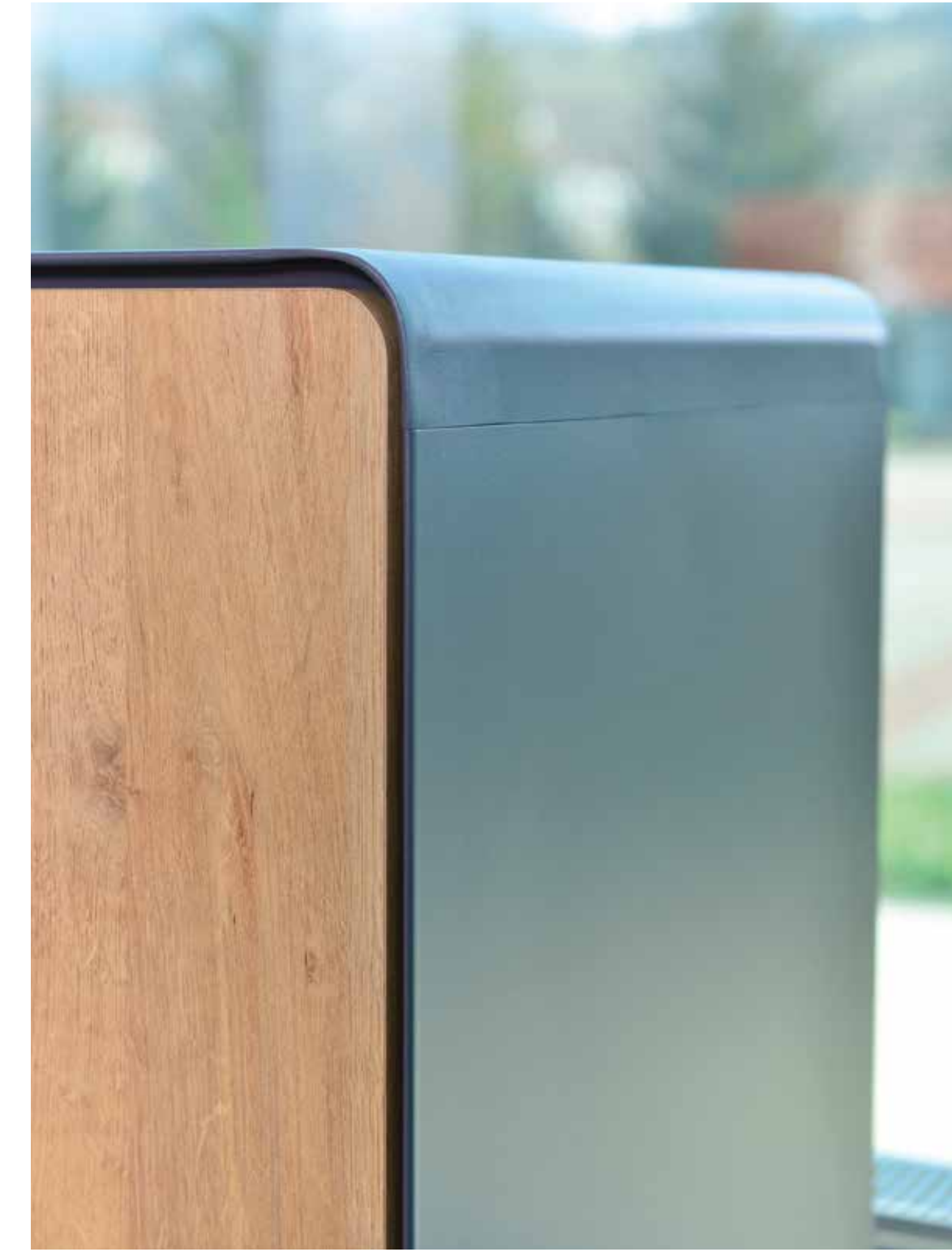

Collective life is a habit that emerged out of people's inherent need for each other. This instinct appears in today's work as the intellectual richness created by making decisions together, sharing responsibility, and exchanging ideas. When we designed this way of working in a suitable form for offices, we focused on forms without corners, inspired by communication. The sense of flexibility, the sense of trust and the collective sense of the cornerless structure are combined in the Trim model. Trim makes collective work enjoyable with its modern lines and design that does not neglect to create personal space. Catch the rhythm of comfortable and efficient working in your offices with Trim.

Yasemin Karadeniz / Yücel Karadeniz

doxa

**PARTNER
IN DESIGN**
Innovative
Design Solutions

TRIM



Melamine
Coating



Electrostatic
Paint



DX Color



Electrification

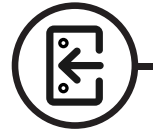

Soft Closing
Door



Soft Closing
Drawing



Scratch
Resistant
Varnish



Modular

OPERATIONAL SERIES



Trim Desk
120-140-160-180x80x75 cm



Trim Desk with Immobile Side Table
180-200x80x75 cm



Trim Metal Body Side Table
80-120x50x60 cm



Trim Metal Body Pedestal
60x50x60 cm

TRIM

- Melamine Coating
- Electrostatic Paint
- DX Color
- Electrification
- Soft Closing Door
- Soft Closing Drawing
- Scratch Resistant Varnish
- Modular

**PARTNER
IN DESIGN**
Innovative
Design Solutions



OPERATIONAL SERIES



Trim Metal Body Cabinet
80x40x88 cm 80x40x128 cm



Trim Metal Body Cabinet
80x40x168 cm 80x40x208 cm



Trim Workstation for Two People
120-140-160x145x75 cm



Trim Workstation for Four People
240-280-320x145x75 cm



Trim Workstation for Six People
360-420-480x145x75 cm

doxa

**PARTNER
IN DESIGN**
Innovative
Design Solutions

TRIM

Storage areas that eliminate the problem of private space for offices with collective workspaces. Reflecting the sense of flexibility and confidence of the angular structure, the collective working suitability was combined in the Trim model.

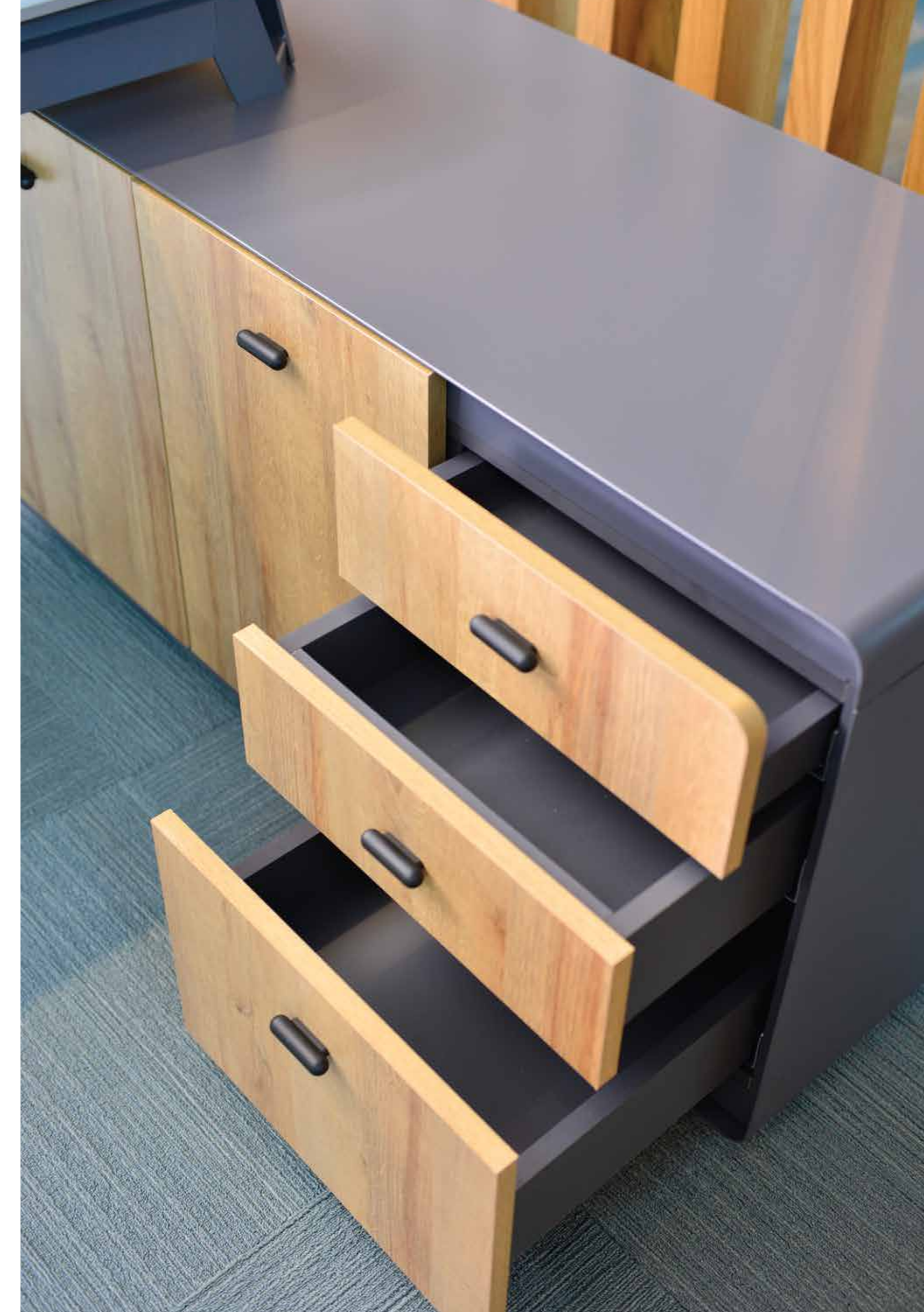

doxa

**PARTNER
IN DESIGN**
Innovative
Design Solutions

TRIM

Trim Desk

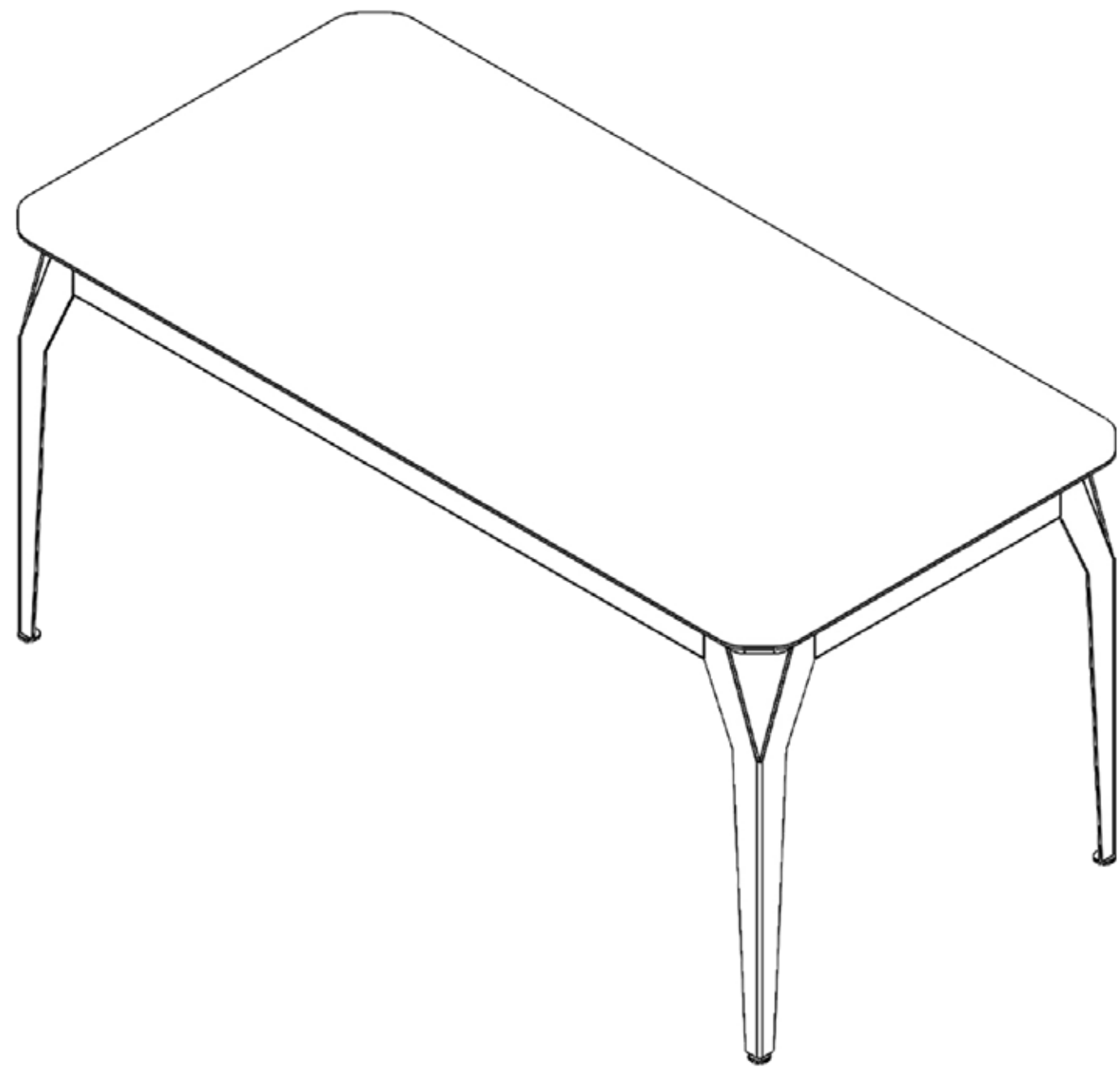

120/140/160/180/200



DESK THICKNESS OPTIONS

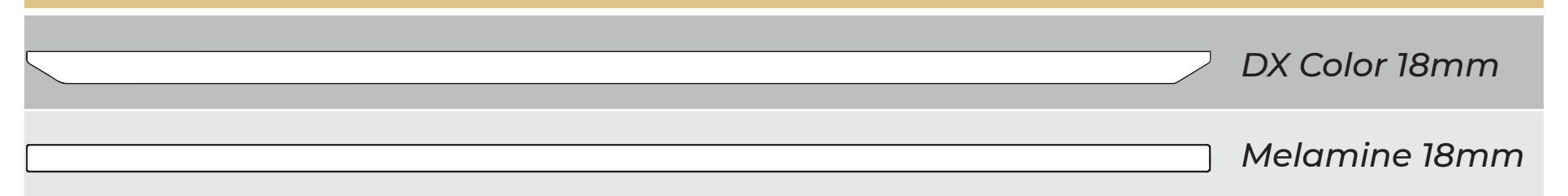

doxa

**PARTNER
IN DESIGN**
Innovative
Design Solutions

TRIM

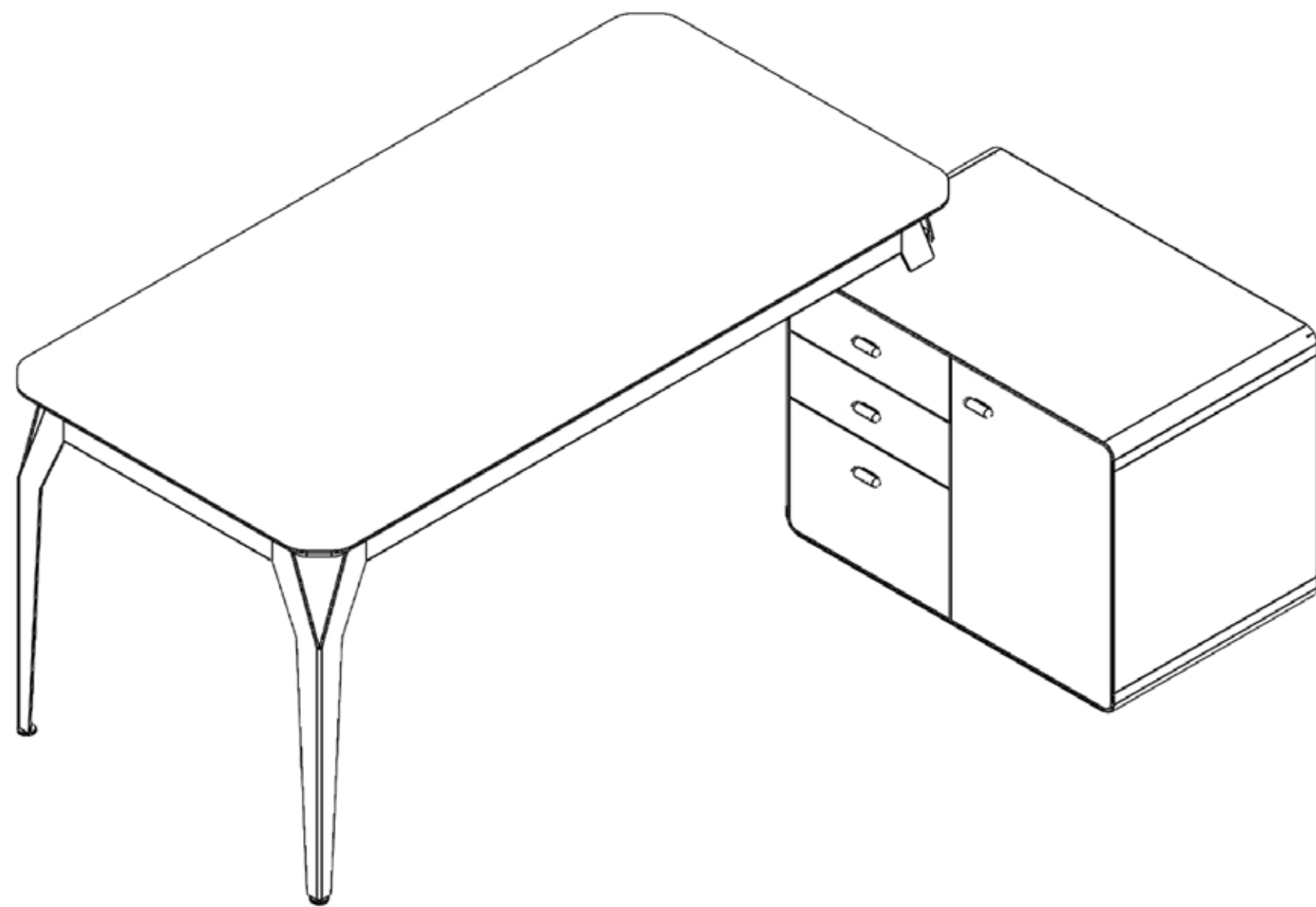

Trim Desk with Immobile Side Table



120/140/160/180/200

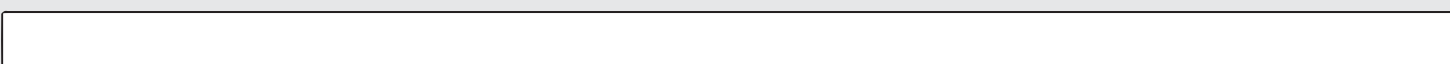

DESK THICKNESS OPTIONS

	DX Color 18mm
	DX Color 30mm
	Melamine 18mm
	Melamine 30mm

doxa

**PARTNER
IN DESIGN**
Innovative
Design Solutions

TRIM

Trim Workstation for Two People

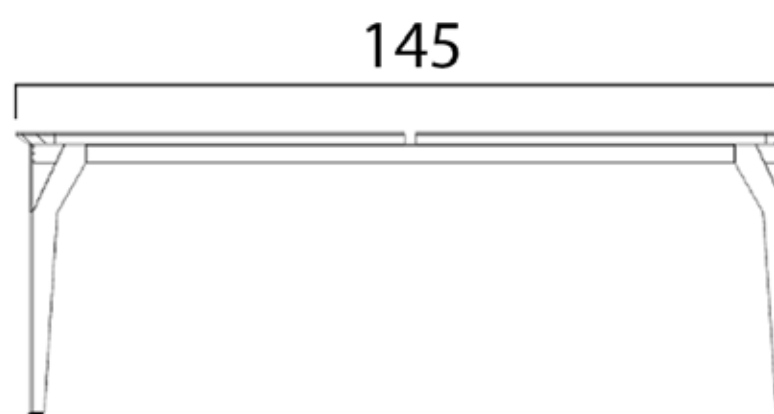
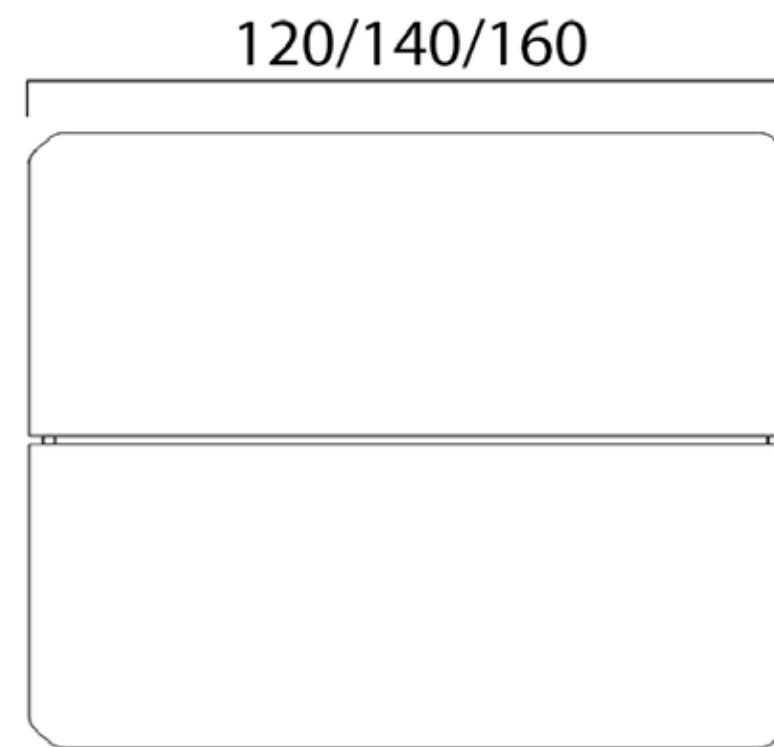
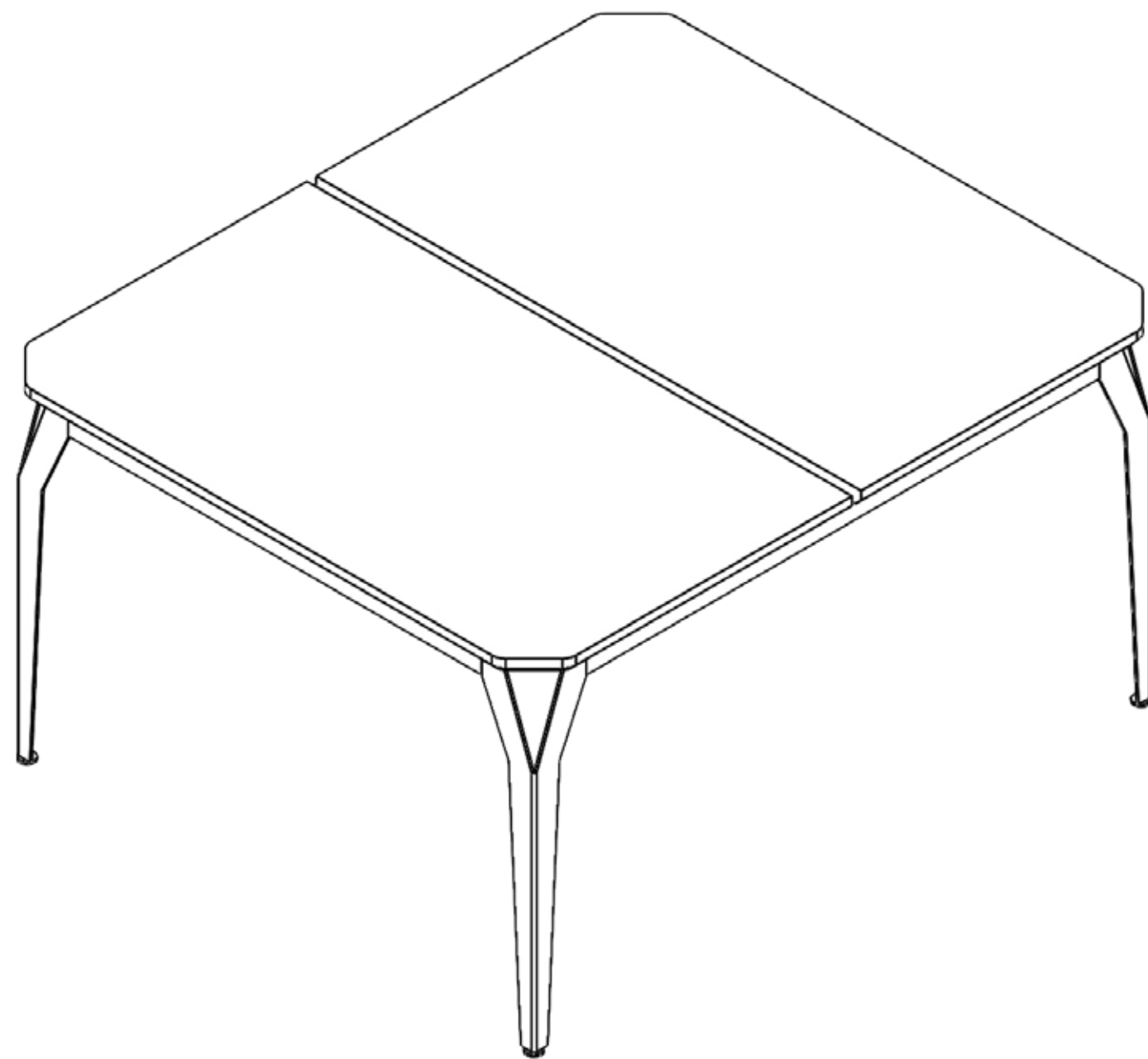

WORKSTATIONS TABLE THICKNESS OPTIONS

	<i>DX Color 18mm</i>
	<i>Melamine 30mm</i>
	<i>Melamine 18mm</i>

doxa



**PARTNER
IN DESIGN**
Innovative
Design Solutions

TRIM

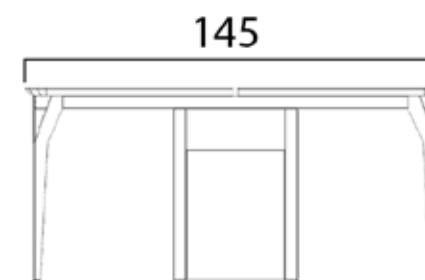
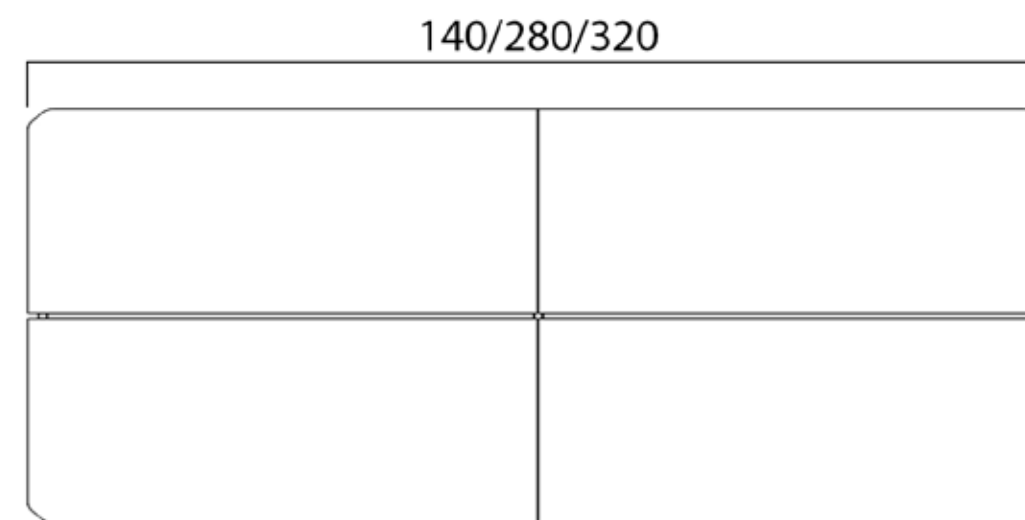
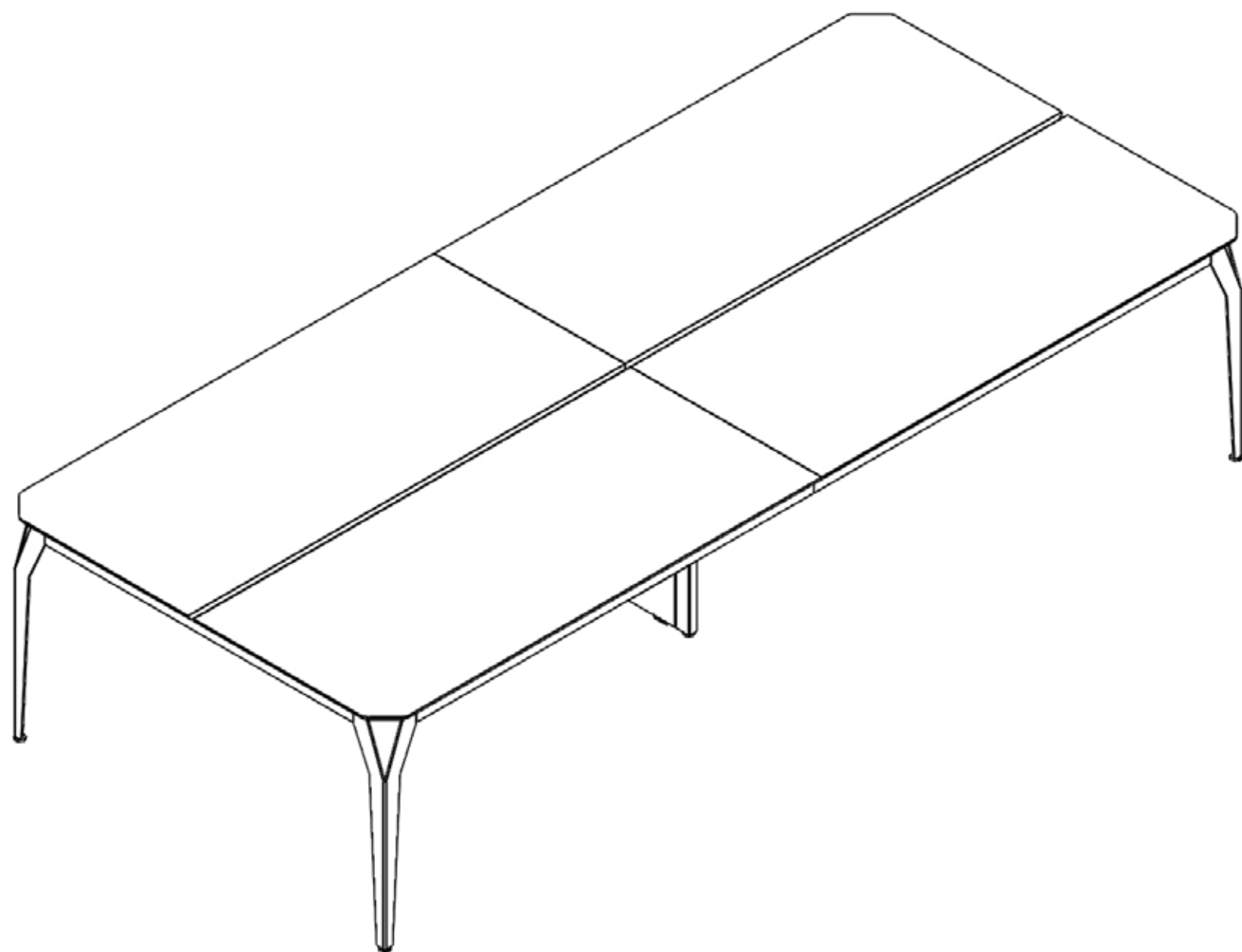
Trim Workstation for Six People



WORKSTATIONS TABLE THICKNESS OPTIONS

	<i>DX Color 18mm</i>
	<i>Melamine 30mm</i>
	<i>Melamine 18mm</i>

doxa



**PARTNER
IN DESIGN**
Innovative
Design Solutions

TRIM

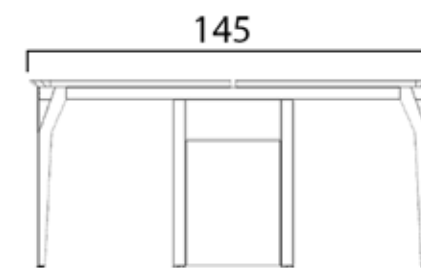
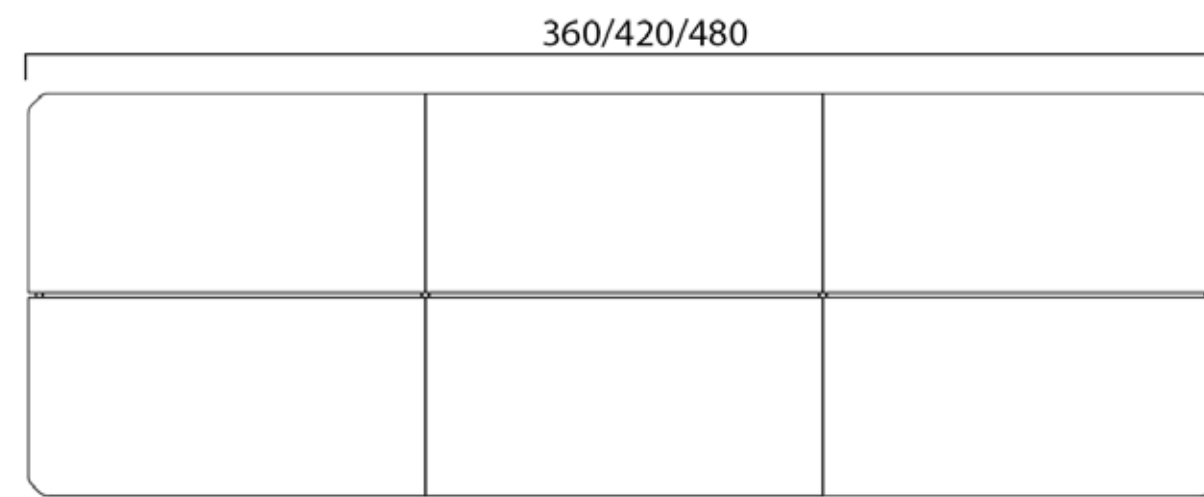
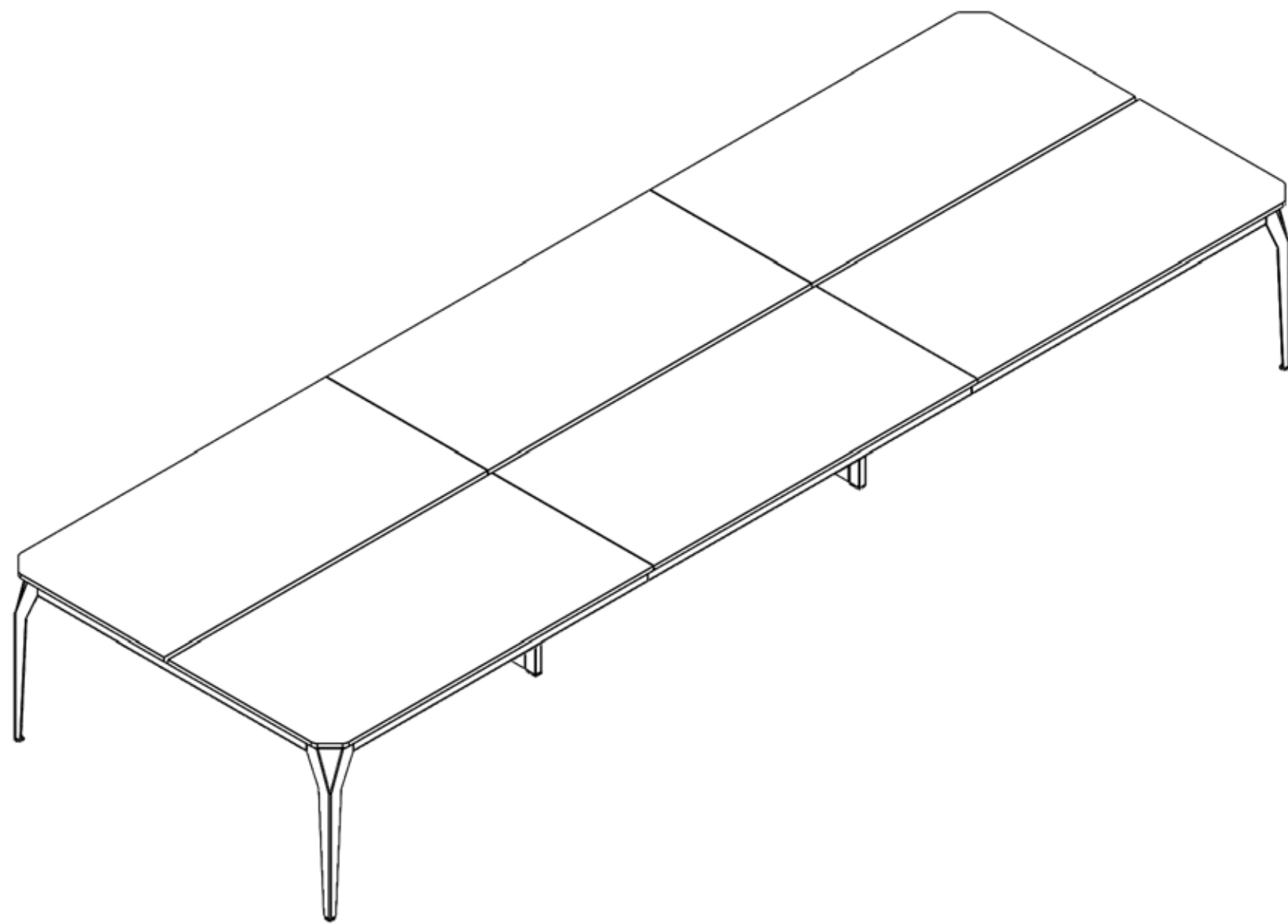
Trim Workstation for Four People

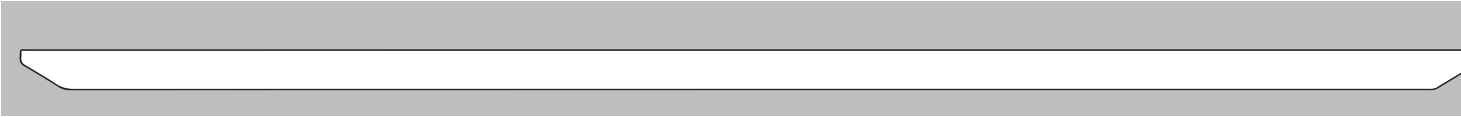

WORKSTATIONS TABLE THICKNESS OPTIONS

	<i>DX Color 18mm</i>
	<i>Melamine 30mm</i>
	<i>Melamine 18mm</i>

doxa

**PARTNER
IN DESIGN**
Innovative
Design Solutions

TRIM

SURFACE MATERIAL

MELAMINE COLORS



BAROQUE



MAPLE



MARBELLA CHERRY



EVEREST



ACACIA



TRABZON OAK



MILANO WALNUT



ARYA

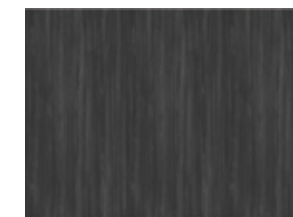

CABANA



ANTHRACITE

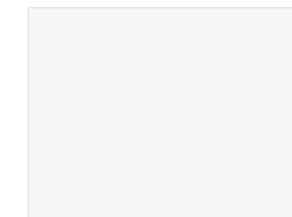

WHITE



BLACK

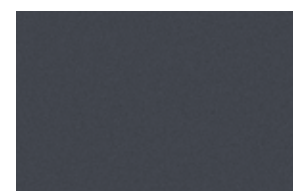

RAL 7015
ANTHRACITE

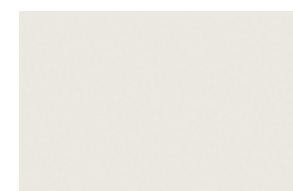

RAL 9016
ECRU WHITE



RAL 9003
GREY

DxColor MDF Powder Coating is a dry solid paint that cures at low temperatures and can be applied to wood-based surfaces. DxColor, a product that respects human health, does not contain harmful components such as solvents, mercury and lead.

LEG COLORS

ELECTROSTATIC PAINT



RAL 7015
ANTHRACITE



RAL 9005
BLACK



RAL 3020
RED



RAL 1023
YELLOW



RAL 2012
ORANGE



RAL 6018
GREEN



RAL 9003
GREY

doxa

Factory

Merkez Mh. Sakaldöken Mevkii,
Çaydeğirmeni / Devrek
Zonguldak / TÜRKİYE

T: +90 372 594 58 02
F: +90 372 594 46 62

Export

Barbaros Mh. Halk Cd. No: 5
Yenisahra / Ataşehir
İstanbul / TÜRKİYE

T: +90 216 324 65 94-95
F: +90 216 472 53 84

www.doxa.com.tr

info@doxa.com.tr

[f](#) [t](#) [i](#) doxa

**PARTNER
IN DESIGN**
Innovative
Design Solutions



Product
catalogue